Quote Info

Reference: 205
Quotation Number: 205
Date of Quotation: 2021-02-16
Quoted By: fyber
Validity: 30 days

Billing Address

ben fyber
fyber
8 fyber road
leeds
yorkshire
LS13 1LL

Dear ben,

Thank you for your valued enquiry, below is a detailed specification for your project. Should you agree with the details, please sign and return the order confirmation sheet enclosed with this Quotation. Should you require any changes please contact me when convenient to yourself.

Quantity	Description	Amount (£)
1	Single Staircase x 1	£360.00
	Subtotal:	£360.00
	Delivery:	£0.00
	VAT:	£72.00
	Total:	£432.00

If you require any help or would like to speak to one of our staff to discuss this please call us on 0113 457 1775

Yours faithfully,
fyber

Please check all dimensions and material spec on this drawing before placing an order.

Assembly and Packaging

The staircase is Assembled

Technical Details

Total Rise: 2600mm

Individual Rise: 13 @ 200mm

Individual Going: 222.12mm

Width Over Strings (mm): 900mm

Specification

Strings: 32mm Redwood Pine (Furniture Grade)

Treads: 22mm MDF Treads

Riser: 9mm MDF Risers

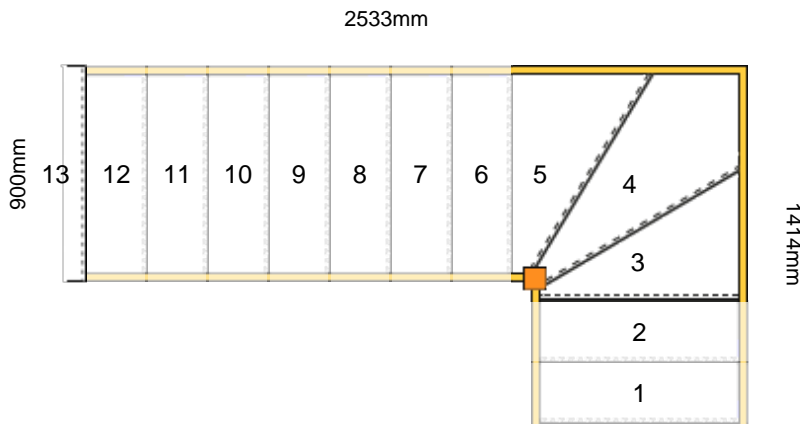

How Will My Staircase Arrive?

Below we will explain how your staircase will be delivered, some companies will not want to say what they do or don't do, so leaving you with more work to do on site that you had hoped for. Here at Express Stairs Yorkshire we do as much for you as we believe is possible without causing you possible problems down the road, everything on the staircase comes fully cut & trenched so all you need to do is put it together.

Staircase Carcass - Unassembled

If you are struggling for access in your property and you chose to order your staircase unassembled then you will receive loose staircase strings, all your treads & risers and any other components for the staircase core pre-cut and trenched to size, (please see photo below) all your wedges & glue blocks will be in a box for your assembly on site.

Staircase Carcass - Pre-assembled

If you have no problem with access then you may wish to order your staircase pre-assembled at no extra charge. This is where the main straight runs of the staircase will be delivered to you already assembled, strings treads & risers. The part of the staircase the comes delivered flat pack would be the staircase turn and newel posts, (please see photo below) these have been dry fitted in our work shop, the only cuts that you may have to do is trim some of the winder risers down to fit in length.

Newel Posts

All newel posts will be delivered at the correct length with all trenching carried out ready to except any treads & risers and strings. Any load bearing newels asked for will be pre-cut to floor level, If you require any other newel posts to be load bearing please inform our sales team or alternatively please add this requirement in your notes section of our online ordering system. Please note all landing newel posts will be supplied as planed blanks 1500mm long.

Handrails & Base Rails & Spindles

All Handrail, Base Rails & Spindles will be delivered un cut, as Express Stairs Yorkshire believes this is better carried out on site, the staircase only has to be fitted slightly out of plumb and then all the cuts are incorrect, also damage can easily happen on site when moving long lengths of handrails around tight corridors and if the mite is caught then the whole length is ruined, we reflect this in our hand rail prices.

Landing Boards

All qtr turn or half landing staircase will be delivered with a landing board, this will need cutting to suit your landing that you will have formed on site, this is because your walls could be slightly out of square etc, you then cut the board we have supplied and fit onto your joists, we also supply strings at the same section of the staircase strings so that if you wish you can follow the string line around you landing board.

Summary

We hope the above gives you an insight of your product will be delivered, if you require any more information please don't hesitate in contacting one of our friendly sales team on info@expressstairs.co.uk or telephone us on 0113 4571775. Click [here to view](#) our Terms & Conditions