

Stair Type:	Straight Staircase
Building Regulations:	UK
Rise:	660mm
Number of Risers:	4
Tread Type:	Closed tread construction
String Material:	32mm Redwood Pine (Furniture Grade)
Tread Material:	22mm MDF Treads
Riser Material:	9mm MDF Risers
Individual Rise:	165mm
Going:	220mm
Overall String Width:	790mm
Nosing Style:	Half Round
Assembly:	Assembled
Est. Delivery Date:	from 22 Feb 21 to 24 Feb 21
Reference:	Staircase 1

Please note

- 1) Labour must NOT be booked until the staircase is delivered.
- 2) Your staircase will be put into production within 24 hrs of placing this order and will be produced according to this drawing.

Stair Type:	Straight Staircase
Building Regulations:	UK
Rise:	630mm

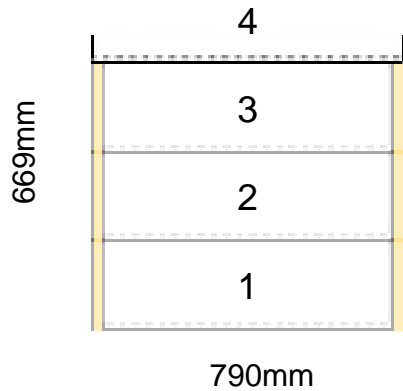

Number of Risers:	4
Tread Type:	Closed tread construction
String Material:	32mm Redwood Pine (Furniture Grade)
Tread Material:	22mm MDF Treads
Riser Material:	9mm MDF Risers
Individual Rise:	157.5mm
Going:	220mm
Overall String Width:	790mm
Nosing Style:	Half Round
Assembly:	Assembled
Est. Delivery Date:	from 22 Feb 21 to 24 Feb 21
Reference:	Staircase 2

Please note

- 1) Labour must NOT be booked until the staircase is delivered.
- 2) Your staircase will be put into production within 24 hrs of placing this order and will be produced according to this drawing.



Stair Type:	Single Staircase
Building Regulations:	UK
Number of Treads in Flight One:	9
Turn One Direction:	Right
Number of Treads in Turn One:	3
Number of Treads in Flight Two:	0
Rise:	2680mm
Number of Risers:	13
Tread Type:	Closed tread construction
String Material:	32mm Redwood Pine (Furniture Grade)
Tread Material:	22mm MDF Treads
Riser Material:	9mm MDF Risers
Winder Tread Material:	22mm MDF Treads

Individual Rise:	206.15mm
Going:	229.81mm
Overall String Width:	790mm
Nosing Style:	Half Round
Bottom Right Newel:	90mm x 90mm Pine
Newel Type:	PSE Newel
Newel Material:	90mm x 90mm Pine
Feature Tread:	bullnose right
Feature Tread Material:	22mm MDF Treads
Assembly:	Assembled
Est. Delivery Date:	from 22 Feb 21 to 24 Feb 21
Reference:	Staircase 3

Please note

- 1) Labour must NOT be booked until the staircase is delivered.
- 2) Your staircase will be put into production within 24 hrs of placing this order and will be produced according to this drawing.



Stair Type:	Straight Staircase
Building Regulations:	UK
Rise:	2380mm
Number of Risers:	11
Tread Type:	Closed tread construction
String Material:	32mm Redwood Pine (Furniture Grade)
Tread Material:	22mm MDF Treads
Riser Material:	9mm MDF Risers
Individual Rise:	216.36mm
Going:	240.3mm
Overall String Width:	790mm
Nosing Style:	Half Round
Top Right Newel:	90mm x 90mm Pine
Bottom Right Newel:	90mm x 90mm Pine
Newel Type:	PSE Newel

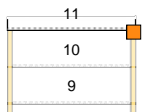

Newel Material:	90mm x 90mm Pine
Feature Tread:	bullnose right
Feature Tread Material:	22mm MDF Treads
Assembly:	Assembled
Est. Delivery Date:	from 22 Feb 21 to 24 Feb 21
Reference:	Staircase 4

Please note

- 1) Labour must NOT be booked until the staircase is delivered.
- 2) Your staircase will be put into production within 24 hrs of placing this order and will be produced according to this drawing.