

Quote Info

Quotation Number: quote215
Date of Quotation: 14-12-2022
Quoted By: fyber
Validity: 30 days

Billing Address

Cameron Conquest
Suite 1b Realtex House
Leeds
CV4 9UQ

Dear Cameron,

Thank you for your valued enquiry. Below is a detailed specification of your project. If you would like to change any of the details of this job, please either email us back or call us as soon as possible so that we can make your changes. If you are happy to proceed with this order please do not hesitate to contact us to discuss your payment options.

Quantity	Description	Amount (£)
1	Single Staircase x 1	£690.00
	Price:	£690.00
	Discount:	£69.00
	Sub Total:	£621.00
	Delivery:	£0.00
	VAT:	£124.20
	Total:	£745.20

If you require any help or would like to speak to one of our staff to discuss this please call us on 01279 598 520

Yours faithfully,
fyber

Please check all dimensions and material spec on this drawing before placing an order.

Assembly and Packaging

The staircase is Assembled

Technical Details

Total Rise: 2600mm

Individual Rise: 13 @ 200mm

Individual Going: 220mm

String Width Flight One (mm): 850mm

String Width Flight Two (mm): 850mm

Specification

Strings: 27mm Redwood Pine Strings (Furniture Grade)

Treads: 25mm MDF Treads

Riser: 12mm MDF Risers

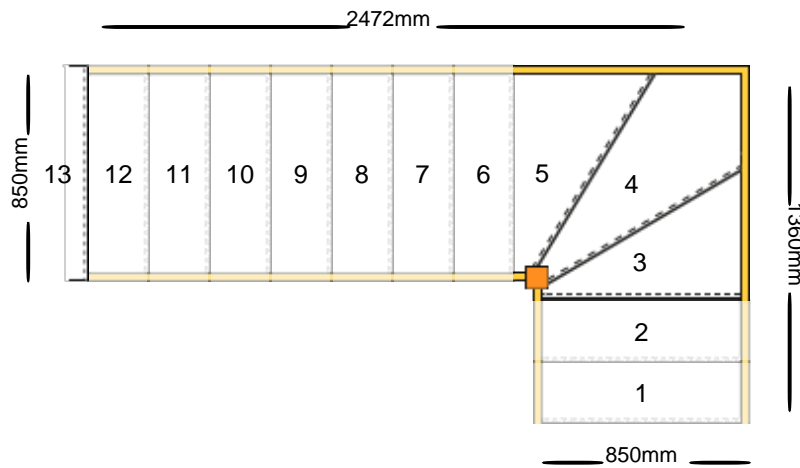

How Will My Staircase Arrive?

Here at staircase-builder.com we make everything as simple as possible for your fitters to assemble and fit the staircase into your home. This means the staircase is fully dry-fitted and put together in our factory before we disassemble it so it can be delivered and easily manoeuvred into your house enabling it to be put back together in situ quickly and without any fuss.

Staircase Carcass

Unassembled

If the access to your property is limited and you chose to order your staircase unassembled then you will receive your staircase strings loose. All your treads & risers and any other components for the staircase will be cut to size and all dry-fitted in our factory as described above. You will also receive a bag of wedges, dowels & glue blocks if you have purchased a staircase with winding treads and newel posts.

Pre-assembled

If you do not have a problem with access then you may wish to order your staircase pre-assembled at no extra charge. This is where the main straight runs of the staircase will be delivered to you already assembled, strings, treads & risers. The only parts of the staircase that will come delivered flat pack will be the winder treads where the staircase turns and also the newel posts. These newels will have been dry-fitted and pre-drilled in our work shop. All the winder risers will be cut and chamfered to fit perfectly in length.

Newel Posts

All newel posts will be delivered at the correct length with all trenching carried out ready to accept any treads, risers and strings. Any load bearing newels purchased will be pre-cut to floor level. If you require any other newel posts to be load bearing please inform our sales team or alternatively please add this requirement in your notes section of our online ordering system. Please note all landing newel posts will be supplied as planed blanks 1500mm long.

Handrails & Base Rails & Spindles

All Handrails, Baseraills & Spindles will be delivered uncut, as the cutting and fitting of this element of the job is better carried out on site. If the staircase is fitted slightly out of plumb then all the cuts will be incorrect if the handrails, baseraills & spindles are pre-cut in our factory.

Summary

We hope the above gives you an insight of how your product will be delivered. If you require any more information please don't hesitate in contacting one of our friendly sales team on sales@timberstaircases.com or telephone us on 01279 598 520.